

moulding

Starter Mouldings

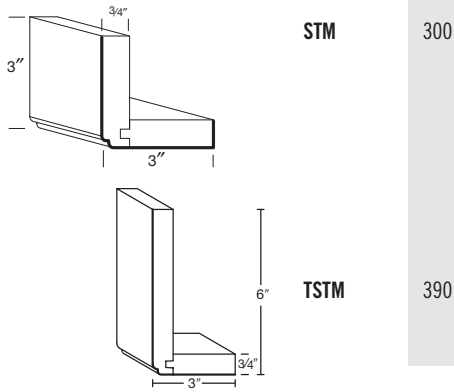

- Starter moulding component for built-up moulding assemblies.
- Similar to full overlay mouldings (moulding with a nailer).
- 8' nominal lengths.

Deluxe Cove



- 8' nominal lengths.

Small Cove Casing

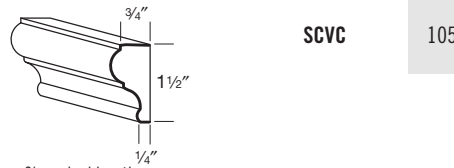

- 8' nominal lengths.

Deluxe Wainscot Cap

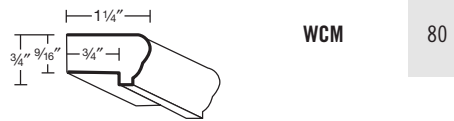

- 8' nominal lengths.

Cove Base Board

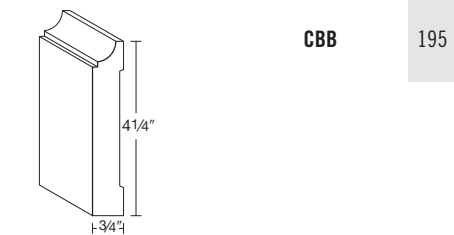

- 8' nominal lengths.

Under Cabinet Moulding

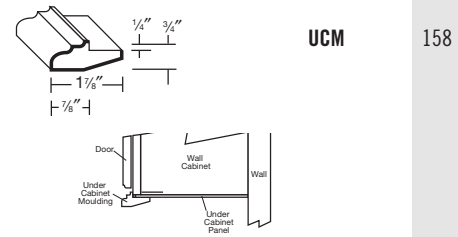

- 8' nominal lengths.
- See Panel Accessories for Under Cabinet Panels.
- Not recommended with MP application.

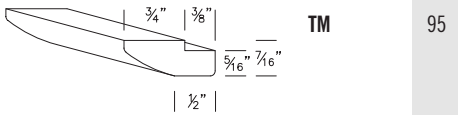

- Fits with 1/8" thick under cabinet panel.
- 8' nominal lengths.
- All finish and glaze combinations available.
- Use when paneling underside of wall cabinets with 1/8" UCP when a minimal front edge detail is desired. See page A.10.
- Vertical application on flush ends to cover applied skin.

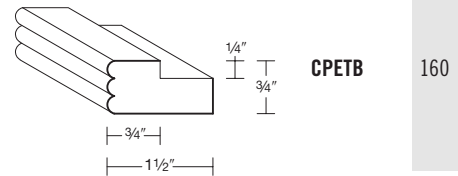
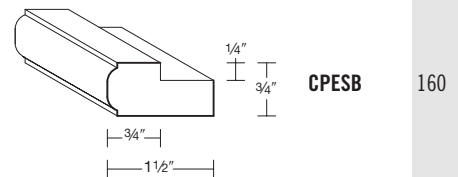
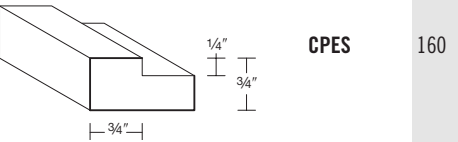

Light Baffle Moulding

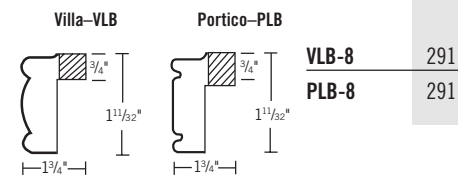

- 8' nominal lengths.

moulding

Light Rails

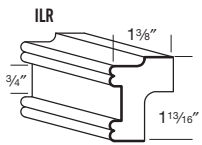

| | |
|-------------|-----|
| ILR | 195 |
| CVLR | 215 |
| SLR | 160 |

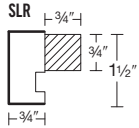
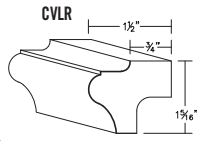

- 8' nominal lengths.
- Rope insert only fits into ILR.

Beaded Moulding

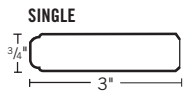

| | |
|-------------|-----|
| SBM8 | 182 |
| TBM8 | 182 |

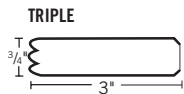

- 8' nominal lengths.

Counterfront Moulding

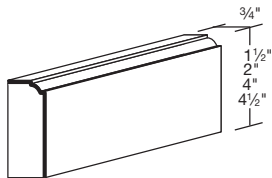

| | |
|---------------|-----|
| CFM1 | 119 |
| CFM2 | 123 |
| CFM4 | 185 |
| CFM4.5 | 204 |

- 8' nominal lengths.
- Both sides profiled=+25%.

Batten Moulding

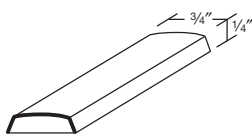

| | |
|--------------------|------|
| BAT | 58 |
| BAT-5 PACK | 259 |
| BAT-50 PACK | 2307 |

- Solid Maple, Oak, Hickory, Cherry and Rustic Alder.
- 8' nominal lengths available in packs of 1, 5, or 50.

Base Shoe Moulding

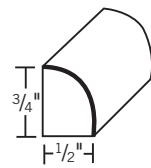

| | |
|------------|----|
| BS8 | 45 |
|------------|----|

- 8' nominal lengths.

Scribe Moulding

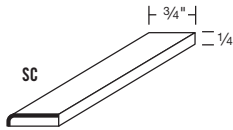

| | |
|-------------------|------|
| SC | 66 |
| SC-1.25 | 80 |
| SC-5 PACK | 278 |
| SC-50 PACK | 2662 |

- 8' nominal lengths available in packs of 1, 5, or 50.

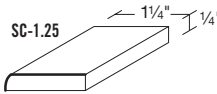

- 8' nominal lengths available; sold individually

Square Scribe Moulding

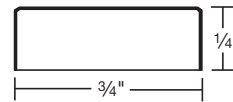

| | |
|------------|----|
| SQC | 95 |
|------------|----|

- Similar to SC but both edges have radius.
- 8' nominal lengths.

Inside Corner Moulding

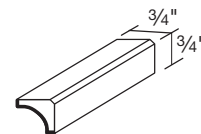

| | |
|-----------|----|
| IC | 70 |
|-----------|----|

- 8' nominal lengths.

Outside Corner Moulding

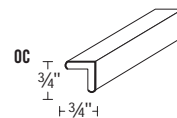

| | |
|-----------|----|
| OC | 74 |
|-----------|----|

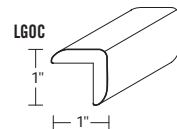

| | |
|-------------|----|
| LGOC | 95 |
|-------------|----|

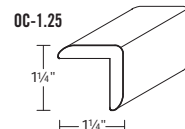

| | |
|----------------|-----|
| OC-1.25 | 116 |
|----------------|-----|

- 8' nominal lengths.

BOLD LINE ON DRAWINGS INDICATES FINISHED SIDES